



# THE PERFECT SOLUTION

## ///ATMOSEAL®

GALVANIZED STEEL  
CLADDING COVER  
ON CANOPY. 

FULLY AUTOMATED  
SYSTEM AVAILABLE. 

"RIP STOP"  
FABRIC PROVIDES  
GREATER  
RESISTANCE TO  
WARE AND TEAR. 



GALVANIZED STEEL  
SIDES AND STRAPPING  
SUPPORTS. 

LONG LASTING HIGH  
QUALITY VINYL WITH  
U.V. STABILIZER  
TO PREVENT CRACKING. 

GALVANIZED  
STEEL MOUNTING  
HARDWARE. 

## SERIES V-1024

## INFLATABLE DOCK TRUCK SHELTER

Designed for door openings up to 10' wide X 10' high, the series V1024 is the optimum solution where a fixed frame shelter is not feasible and a variety of different height and width trailers are serviced. The Series V1024 is uniquely designed to provide complete access to the trailer openings. Ideal for problem dock areas such as sloped and difficult driveway approaches. Excellent for installation on metal sided building walls. Super Seal's exclusive 16 oz. "Rip Stop" fabric developed specifically for inflatable products will give years of trouble-free service. The series V1024 creates an optimum seal that blocks out foul weather, insects, dust and dirt, while saving money on energy costs. The inflatable truck seal helps productivity by increasing safety, protecting personnel, products and equipment. Series V1024 standard dimensions for door openings 10' wide X 10' high are 11'4" wide X 11'8" high with a 24" projection, and a 48" header air bag when inflated. The V1024 seals trailers 10'6" to 13'6" high from grade with a dock height of 48".

**SUPER**  **SEAL**

Tel: 905.850.2929 Tel: 1.800.337.3239  
Fax: 905.850.2922 Fax: 905.850.4440

[www.supersealmfg.com](http://www.supersealmfg.com)

SuperSeal Mfg. Ltd.  
670 Rowntree Dairy Rd.,  
Woodbridge, Ontario, Canada L4L 5T8

## SPECIFICATIONS

### Series V-1024 Product Details:

- Series V-1024 standard dimensions for door openings 10'W x 10'H are 11'4" wide x 11'8" high (O.D.) with a 24" projection, and a 48" header air bag when inflated.
- Seals trailer 10'6" to 13'6" high from grade with a dock height of 48".
- Exclusive 16 oz. "RipStop" fabric developed specifically for inflatable units gives years of trouble free service.
- Can be part of a totally automated dock loading system.
- Gives full access to the trailer opening.
- Designed for standard 5" bumper projection.

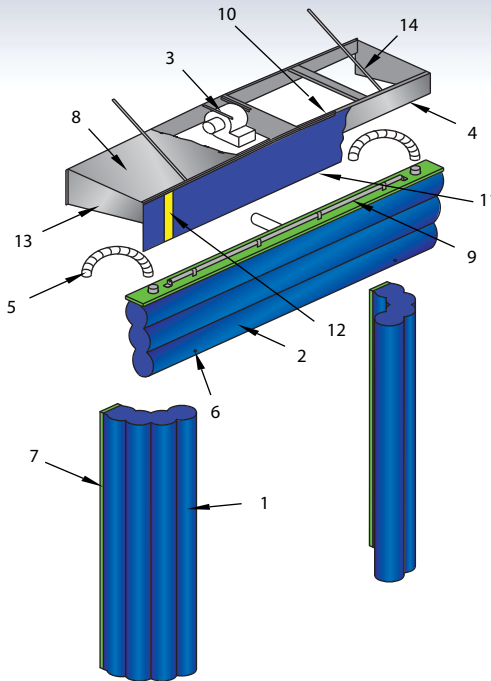

1. Vertical Air Bag
2. Header Air Bag
3. Motor/Blower
4. Pressure Treated Wood Canopy
5. Air Connector Ducts
6. Air Vents
7. Pressure Treated Wood Backing
8. Galvanized Colour Steel Cladding
9. Torsion Spring Assembly
10. Finish Angle Trim
11. Reinforced Vinyl Curtain
12. 4" Yellow Guide Stripe
13. Side Supports
14. Canopy Support Straps

### Specifications:

Retractable inflatable truck shelter(s) to be Series V1024 as manufactured by Super Seal Mfg. Ltd., Woodbridge, Ontario. Retractable inflatable truck shelter(s) to be manufactured to fit door opening size(s) \_\_\_\_ft. wide X \_\_\_\_ft. high. Units to consist of two (2) vertical air bags, to be fastened onto a 2" X 8" pressure treated wood frame, (supplied unassembled by manufacturer) using galvanized wood screws. The bottom of the vertical seals to have an inflatable bottom corner seal which will include holes for venting of air and to assist in moisture drainage. Inflatable header air bag to be full width over vertical seals mounted on a pressure treated wood frame. Inflatable header air bag in deflated mode is stored behind a reinforced vinyl curtain with a 4" yellow stripe to aid in the spotting of trailers. Unit to be supplied with 1/2 HP, motor/blower with a manual ON/OFF switch. The motor/blower shall be mounted under a protective canopy constructed of pressure treated wood framework covered with galvanized colour steel cladding. The top canopy shall be peaked to allow for drainage and shall be fastened to the wall by means of a galvanized steel side and strapping supports. Unit is inflated by turning switch on and deflates automatically when unit is turned off by means of internal pulley and retraction arm system for the verticals and a torsion roller assembly for the header. Unit to be manufactured of exclusive 16 oz. vinyl "RipStop" fabric double-stitched, high strength twisted 4 ply 100% polyester bonded thread UV treated used for sewing throughout. Unit shall be furnished with all necessary mounting hardware, galvanized to resist corrosion.

### Options:

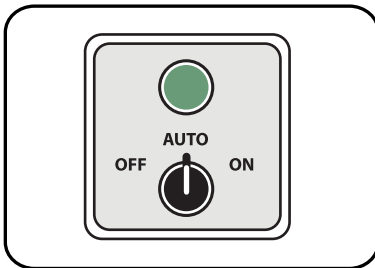

A. Automatic Switch Kit

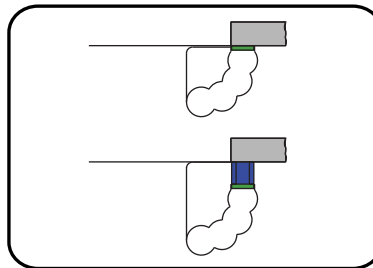

B. Extended Projection

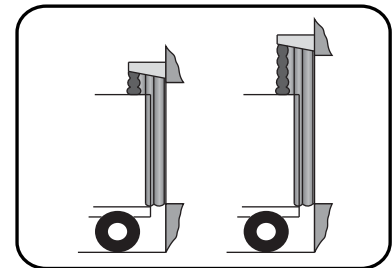

C. Higher Units

