

THE PERFECT SOLUTION



Long-lasting, high quality vinyl with U.V stabilizer to prevent fading

Wood-backing is made with the highest quality pressure treated wood

No structure to crush, high density memory foam compresses on all sides

Adjustable header for trailers with varied heights

Equipped with steel rollers led along by heavy duty galvanized steel tracks

Yellow guide stripe is vulcanized (heat sealed) not sewed on

Galvanized steel mounting hardware

SERIES 0351

ADJUSTABLE HEADER TRUCK DOCK SEAL

Designed to service a variety of trucks with varying trailer heights, the Series 0351 Adjustable Header Dock Seal provides a superior air-tight seal between the building and the back end of the trailer for dock openings up to 8'W x 10'H. The head pad is mounted with rollers in a heavy duty steel guide track permitting easy and precise adjustment while automatically maintaining a weather-tight environmental seal. The resilient foam pads can be covered with a large selection of tough abrasion resistant fabrics creating a tight seal that blocks out foul weather, insects, dust, and may reduce theft while saving money on energy costs. The Series 0351 will increase the comfort and productivity by increasing safety, protecting personnel, products, and equipment.



Series 0351 Product Details:

- Series 0351 standard dimensions for door openings 8'W x 10'H have (2) two 10' high vertical pads with a 12" face, cube shaped, and (1) one 8' long head curtain with a 36" drop. Unit projection is 10".
- Seals trailers 11' to 13'6" H from grade with a dock height of 48".
- A large selection of cover fabrics available including our exclusive SS-90-1 High performance vinyl and 16 oz. vinyl "RipStop". Other fabrics and colours are available include: hypalons and vinyls (see Material Selection Guide).
- The 0351 can be fitted for openings up to 9' W x 12' H by the use of a longer follower curtain.
- 4" to 6" maximum pad projection in front of the dock bumper face is recommended to prevent over compression, excessive wear and tear and undue building wall pressure.

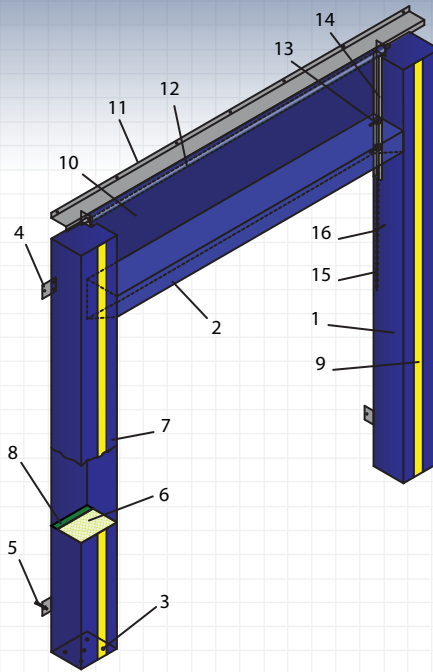

1. Vertical pad
2. Adjustable head curtain
3. Air vents holes
4. Galvanized mounting brackets
5. 3/8" sleeve anchor bolts
6. Polyurethane foam core
7. Cover fabric
8. Pressure treated wood backing
9. 4" wide yellow guide stripe
10. Header follower curtain
11. Header assembly cover
12. Torsion spring
13. Roller assembly
14. Galvanized steel track
15. Pull chain
16. Screw hook

Specifications:

Dock seal(s) to be Series 0351 as manufactured by Super Seal Mfg. Ltd., Woodbridge, Ontario. Dock seal(s) to be manufactured to fit door opening size(s) _____ ft. wide x _____ ft. high. Vertical pads to be manufactured using pressure treated wood, and a high density, light weight urethane foam core with 98% compression recovery and maintaining flexibility at -40°. The foam core shall be continuously bonded (not spot glued) to the wood backing with a high quality, non-flammable elastic adhesive. Cover fabric shall be double stitched with high strength twisted 4 ply 100% polyester bonded thread U.V. treated. The cover fabric overlaps the wood backing totally enclosing it and is fastened with heavy duty plated staples. Vertical pads are vented through holes allowing air to be exhausted and moisture to drain. Vertical pads are tapered cut at the bottom to prevent sagging, pinching, wearing when compressed and tapered cut at top to provide adequate drainage. Vertical pads have a 24" high 4" wide yellow guide stripe to aid in spotting trailers. The adjustable head pad shall be equipped with steel rollers that glide up and down in a formed heavy duty galvanized steel track. An integral follower curtain shall be supplied to maintain a weather-tight environmental seal. The head pad is lowered against the trailer by means of 2 pull chains. The header automatically raises to the up position once released. A galvanized steel header assembly cover is provided to protect the roller and torsion spring assembly. Unit shall be furnished with all necessary mounting hardware, galvanized to resist corrosion

Options:

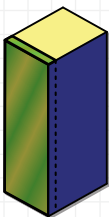

A. Cover material overlaps edges only

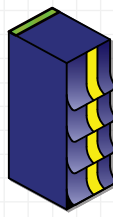

B. Protective flap (4", 8" & 16" exposure)

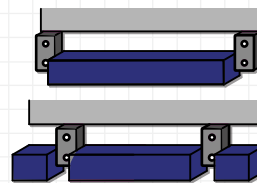

C. Bottom pads

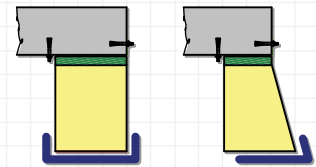

D. Double layer of material on impact areas

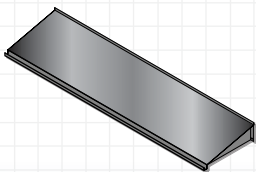

E. Galvanized steel canopy

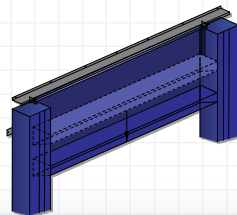

F. Longer Travel

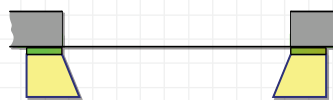

G. Bevelled vertical pad

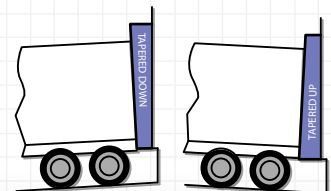

H. Tapered units



DEALER IMPRINT



** All Super Seal products are subject to design modifications without notice. Product may be shown with non-standard options.

Custom Designs Available!